

Warning:

Disconnect +V BEFORE connecting USB cable.

Wiegand Interface:

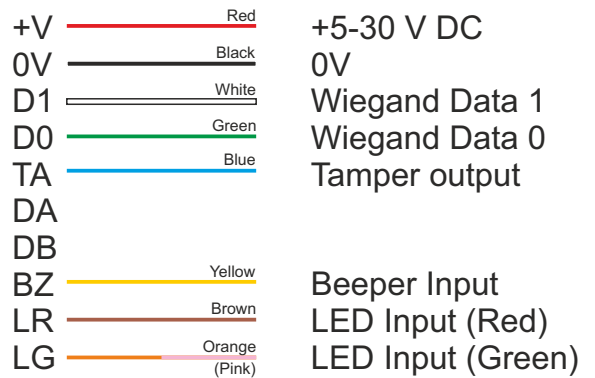

OSDP Interface:

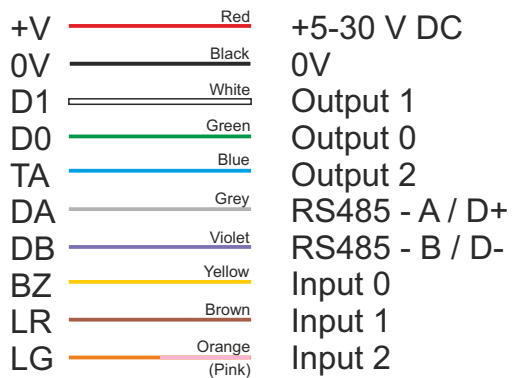

Clock/Data Interface:

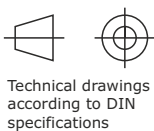
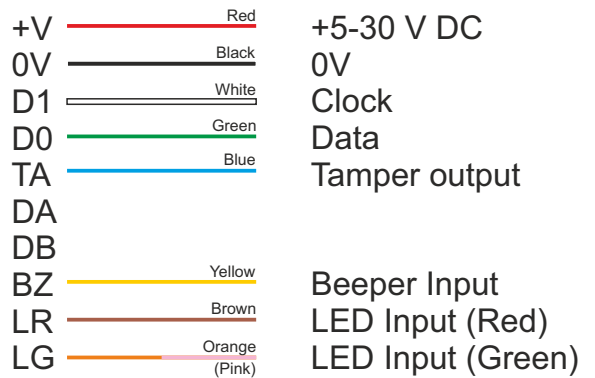

SECURITY ENGINEERING

Tel.: +45 87 30 04 45
www.securityengineering.dk

Design : SE 1044 DT / DKT

Subject : MIFARE/DESFire card reader for OSDP bus

Scale :

Dato : 2023-12-28

Rev.: B

Card Reader Configuration

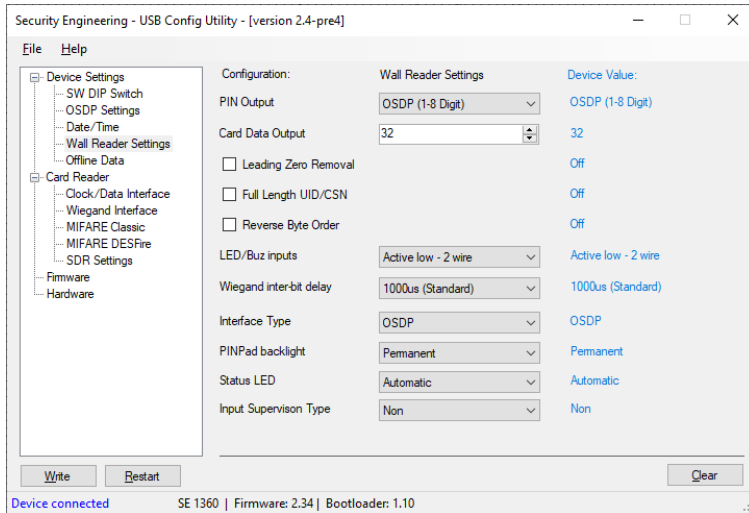

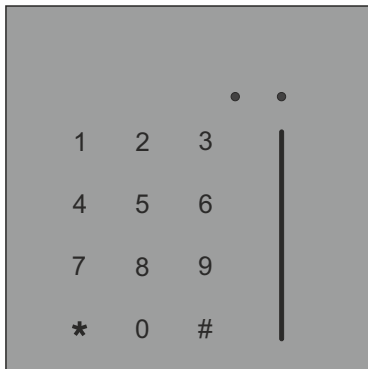

Warning:
Disconnect +V BEFORE connecting USB cable.

Card Reader readID for Siedle

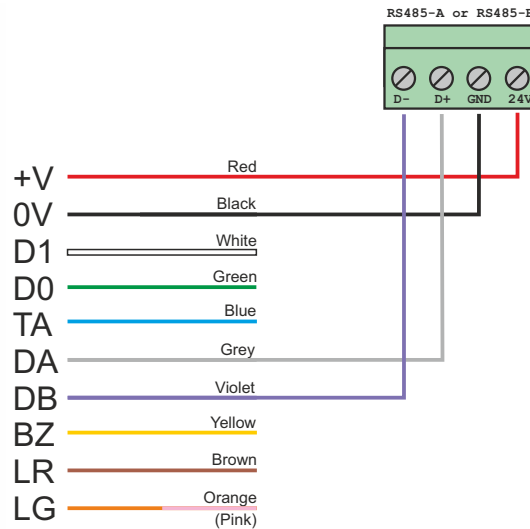

Door Controller TechPoint



Technical drawings
according to DIN
specifications

SECURITY
ENGINEERING

Tel.: +45 87 30 04 45
www.securityengineering.dk

Design : SE 1044 DT / DKT

Subject : Connections to TechPoint

Scale :

Dato : 2023-12-28

Rev.: A

Card Reader Configuration

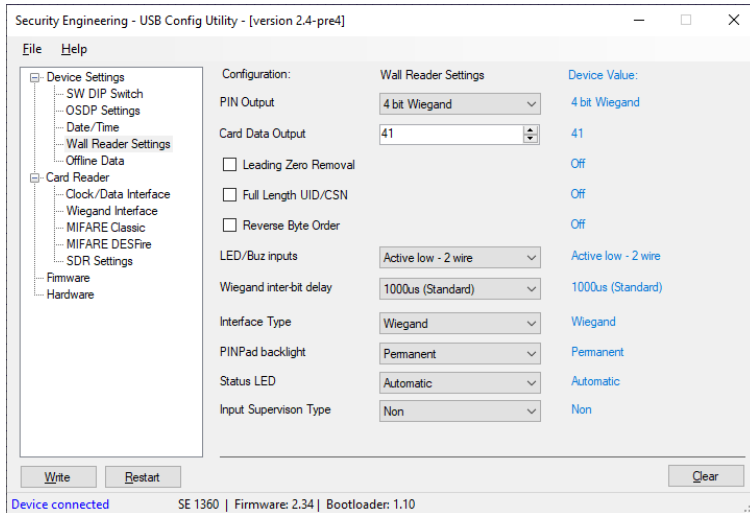

Warning:
Disconnect +V BEFORE connecting USB cable.

Card Reader
readID for Siedle

Door Controller
Vanderbilt SPCA210

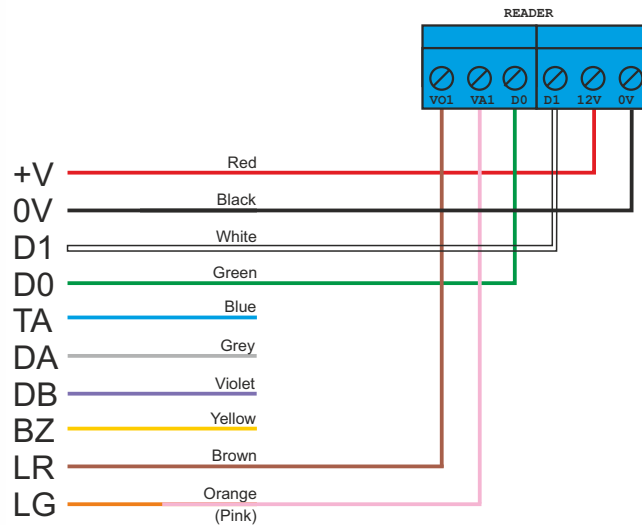
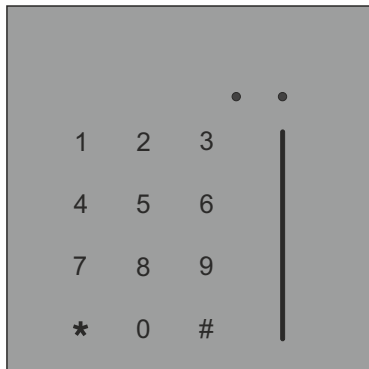

Technical drawings
according to DIN
specifications

SECURITY
ENGINEERING

Tel.: +45 87 30 04 45
www.securityengineering.dk

Design : SE 1044 DT / DKT

Subject : Connections to Vanderbilt SPC A210

Scale :

Dato : 2023-12-28

Rev.: A

Card Reader Configuration

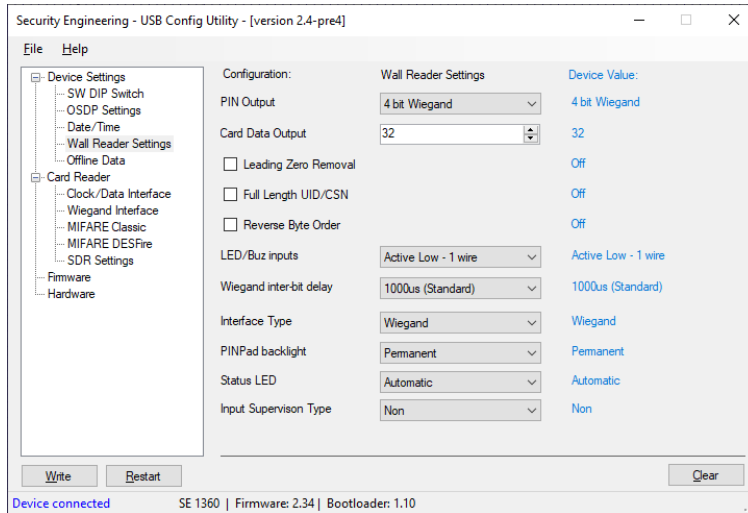

Warning:
Disconnect +V BEFORE connecting USB cable.

Card Reader
readID for Siedle

Door Controller
NOX CMU

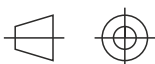

Technical drawings
according to DIN
specifications

SECURITY
ENGINEERING

Tel.: +45 87 30 04 45
www.securityengineering.dk

Design : SE 1044 DT / DKT

Subject : Connections to NOX CMU

Scale :

Dato : 2023-12-28

Rev.: A

Card Reader Configuration

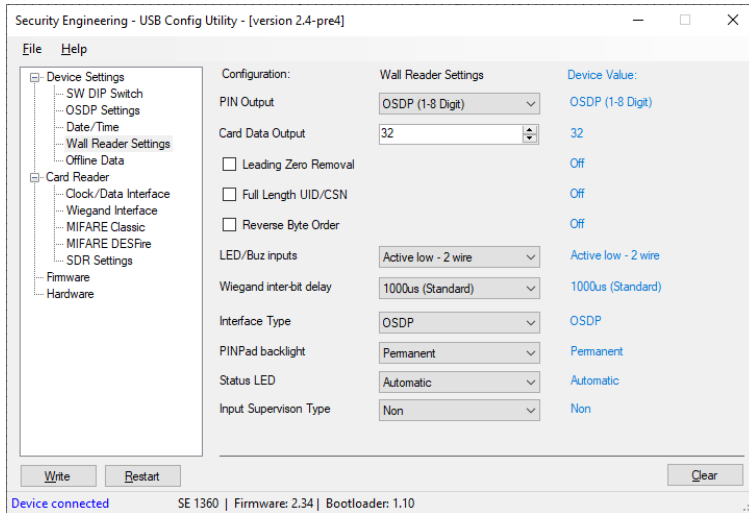

Warning:
Disconnect +V BEFORE connecting USB cable.

Card Reader
readID for Siedle

Door Controller
NOX CMO

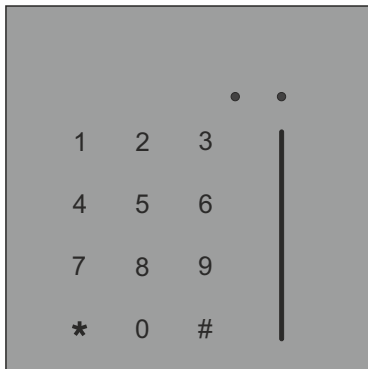

+V	Red
0V	Black
D1	White
D0	Green
TA	Blue
DA	Grey
DB	Violet
BZ	Yellow
LR	Brown
LG	Orange (Pink)

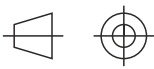
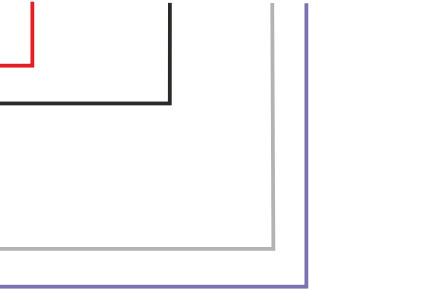
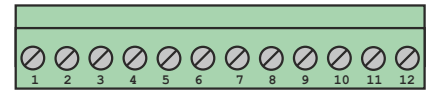

Technical drawings
according to DIN
specifications

SECURITY
ENGINEERING

Tel.: +45 87 30 04 45
www.securityengineering.dk

Design : SE 1044 DT / DKT

Subject : Connections to NOX CM0

Scale :

Dato : 2023-12-28

Rev.: A

Card Reader Configuration

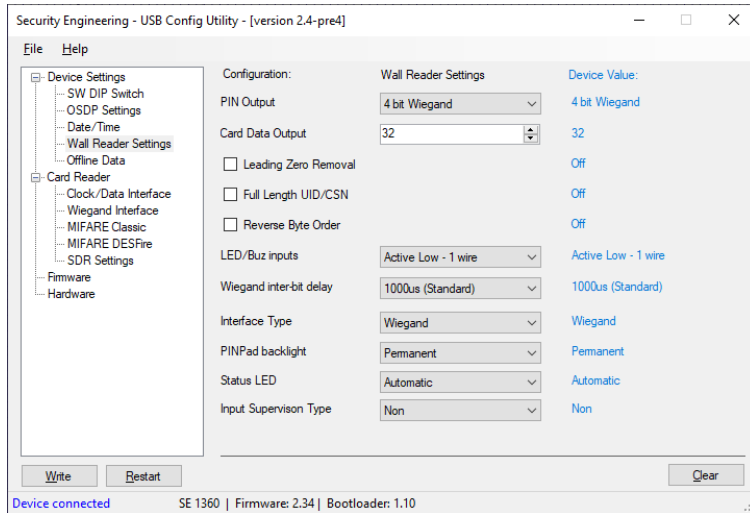

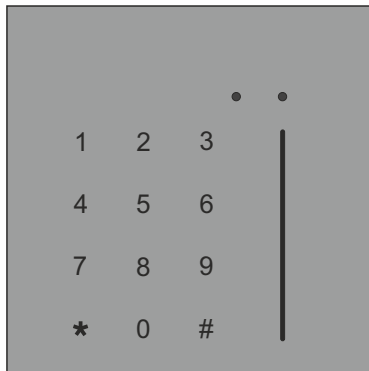

Warning:
Disconnect +V BEFORE connecting USB cable.

Card Reader readID for Siedle

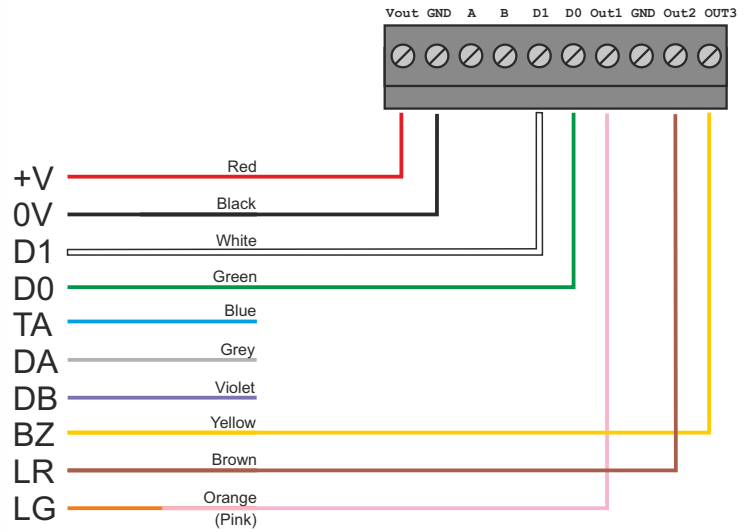

Door Controller Nedap AEOS Blue (Wiegand)



Technical drawings according to DIN specifications

SECURITY
ENGINEERING

Tel.: +45 87 30 04 45
www.securityengineering.dk

Design : SE 1044 DT / DKT

Subject : Connections to Nedap AEOS Blue Wiegand

Scale :

Dato : 2023-12-28

Rev.: A

Card Reader Configuration

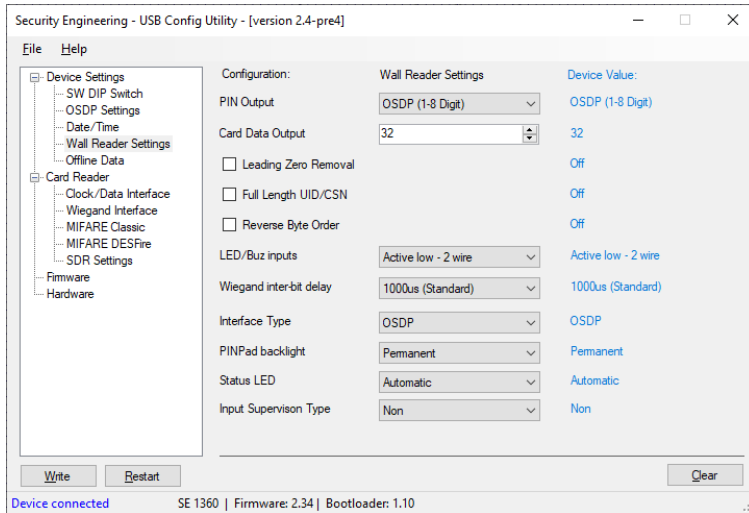

Warning:
Disconnect +V BEFORE connecting USB cable.

Card Reader readID for Siedle

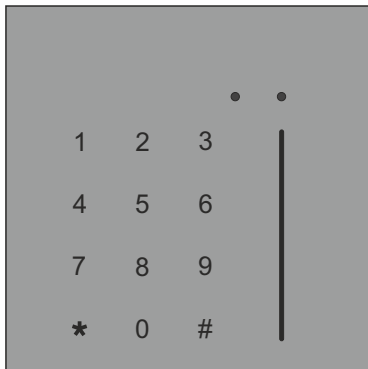

Door Controller Nedap AEOS Blue (OSDP)

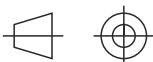
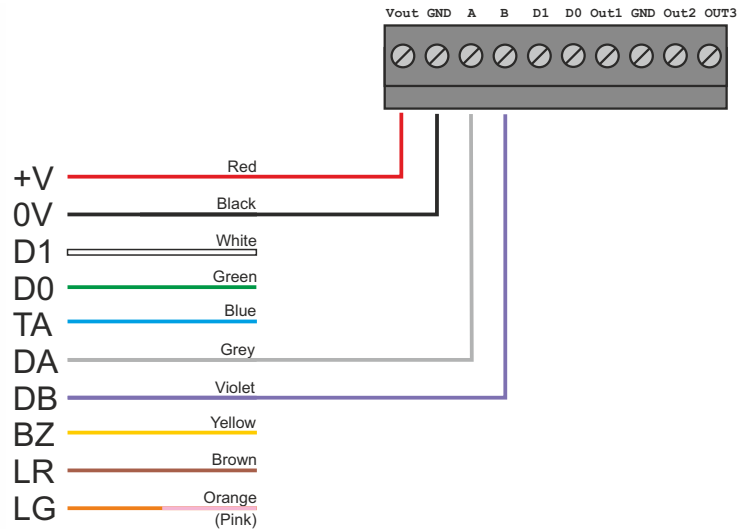

Technical drawings
according to DIN
specifications

SECURITY
ENGINEERING

Tel.: +45 87 30 04 45
www.securityengineering.dk

Design : SE 1044 DT / DKT

Subject : Connections to Nedap AEOS Blue - OSDP

Scale :

Dato : 2023-12-28

Rev.: A